

# GO REGULATOR

## DL-59

### Dome Loaded Pressure Regulator



Responding to the needs of the industry for a simple, safe and effective way to remotely load high pressure regulators, GO Regulator designed and developed a line of low profile dome loading units.

This compact and robust design employs a unique "Dual Piston" set up which enables the user to control pressures up to 4,000 psig with as little as 36 psig of dome pressure. All of this is accomplished within the smallest envelope the industry has to offer!

The regulator portion of this unit was patterned after the time tested PR-59 Series, which is widely recognized as a benchmark of performance and quality. Offering the utmost in safety and corrosion prevention, this unit is constructed from 316L stainless steel. A carefully engineered piston sensor unit offers good sensitivity and repeatability. This is coupled with the large  $C_v$  of the PR-59 of 1.20.

Completing this design is the addition of an anodized aluminum (316 stainless steel optional) dome unit. The inlet ring to the dome is freely rotating and captured by a high tensile snap ring. This feature allows easy positioning and alignment of the dome gas line within a customer's system while maintaining excellent leak integrity.

#### Features & Specifications      Applications

- |   |  |
|---|--|
| <ul style="list-style-type: none"><li>• Gas or liquid service</li><li>• 316L stainless steel construction (brass &amp; Monel optional)</li><li>• Better than 25 Ra finish in diaphragm cavity</li><li>• Stainless steel piston sensor</li><li>• <math>C_v</math> of 1.20 is standard</li><li>• 20 micron inlet filter</li><li>• Bubble tight shutoff</li><li>• Dome ratios are 11:1, 20:1, 43:1, 56:1, 76:1, 108:1, 122:1, and 172:1</li><li>• Outlet pressures up to 4000 psig</li></ul> | <ul style="list-style-type: none"><li>• Pilot plant</li><li>• Pneumatic high flow test benches</li><li>• Bulk gas delivery</li><li>• R &amp; D systems</li></ul> |
|---|--|

405 Centura Court  
PO Box 4866  
Spartanburg, SC 29303  
tel 864.574.7966  
fax 864.587.5608  
www.goreg.com  
sales@goreg.com

# DL-59

## Dome Loaded Pressure Regulator

### How to Order

See page 3 for standard configurations. For additional Configurations, consult the factory.  
See page 4 for port locations.

### Maximum Temperature & Operating Inlet Pressures

Seat Material	Maximum Temperature	@	Maximum Operating Inlet Pressure
PCTFE (formerly Kel-F 81®)	175° F (80° C)	@	4000 psig (27.58 MPa)
Teflon®	150° F (66° C)	@	1000 psig (6.90 MPa)

Tefzel® and Teflon® are registered trademarks of Dupont.

### Outline and Mounting Dimensions

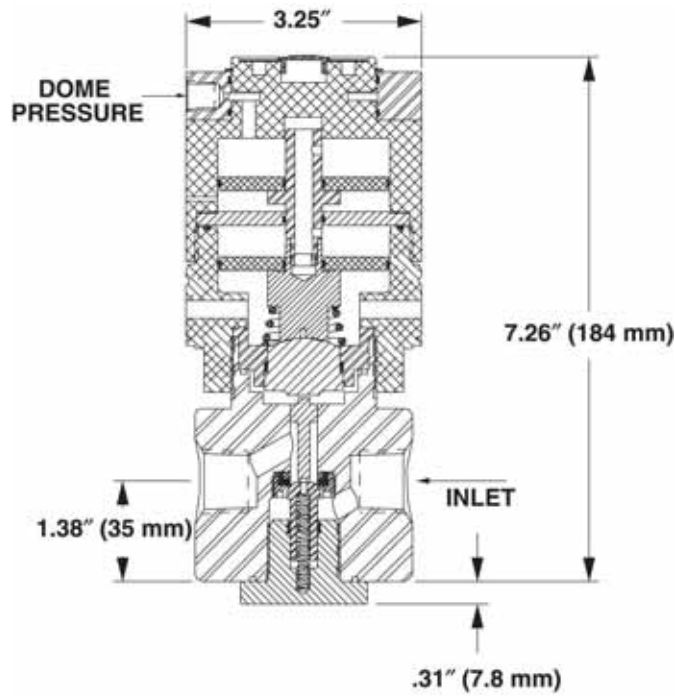

# DL-59 Series - Pressure Reducing Regulator

<b>Material of Body</b>									
1	SS 316L								
2	Brass								
4	Monel								
<b>Port Configuration (see page 4)</b> STANDARD BODY "A" (ONE INLET PORT AND ONE OUTLET PORT)									
<b>Process port types (gauge port type, if specified)</b>									
5	1/2" FNPT (1/4" FNPT Gauge Ports)								
A	3/4" FNPT (1/4" FNPT Gauge Ports)								
B	3/4" ISO 7 Parallel (1/4" FNPT Gauge Ports)								
<b>Surface Finish of Diaphragm Cavity</b>									
1	<25 Ra								
<b>Seat Material</b>									
H	PCTFE (formerly Kel-F 81)								
I	Teflon								
<b>Flow Coefficient (Cv)</b>									
9	1.2								
<b>Dome Ratio</b>									
0	11 : 1								
1	43 : 1								
2	56 : 1								
3	76 : 1								
4	108 : 1								
5	122 : 1								
6	172 : 1								
7	20 : 1								
<b>Piston Type</b>									
1	Non Self Relieving								
3	Self Relieving								
<b>Piston Material</b>									
5	Stainless Steel								
B	Monel								
<b>Dome Style</b>									
1	Standard, Aluminum								
2	Captured Vent, Aluminum								
3	S.S.								
4	Captured Vent, S.S.								

DL59 -

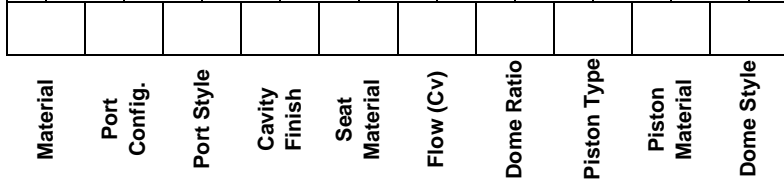

# SINGLE STAGE PRESSURE REDUCING & BACK PRESSURE PORTING CONFIGURATIONS

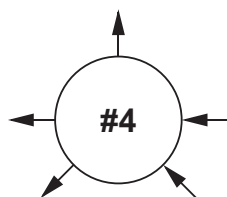
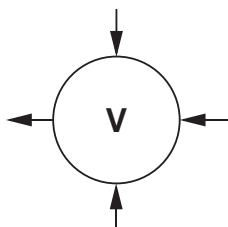
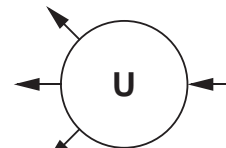
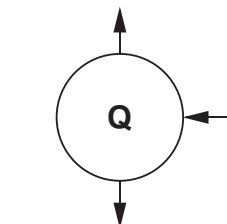
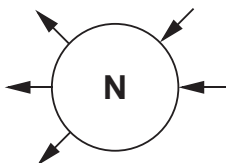
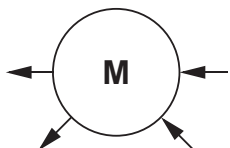
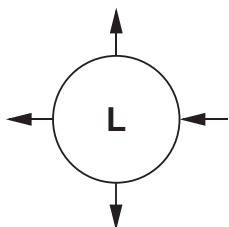
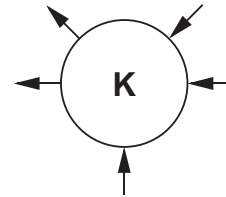
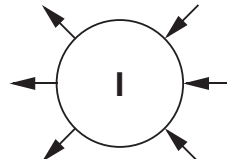
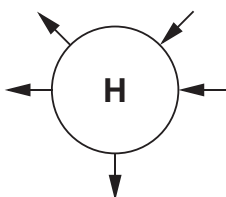
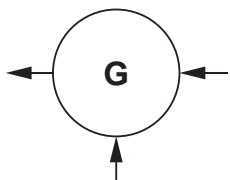
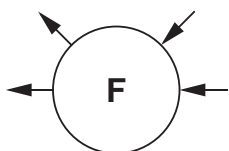
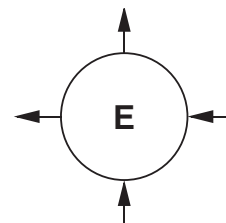
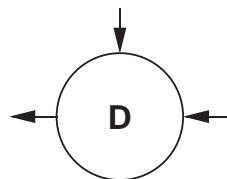
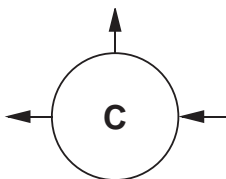
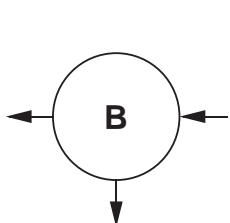
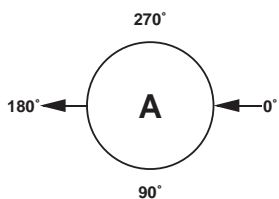

ARROW POINTING TOWARD BODY IS INLET  
ARROW POINTING AWAY FROM BODY IS OUTLET